

## FOLDING BASSINET FOR STORAGE & TRAVEL

1. Remove the mattress and fold inwards. Secure the halves together by pressing the hook and loop patches together.
2. Locate the fabric loop and thumb print button inside the bassinet. (Fig. B1)
3. Push button while lifting loop. Pull upwards until the legs fold together. (Fig. B2)
4. Place bassinet and mattress into the travel bag.

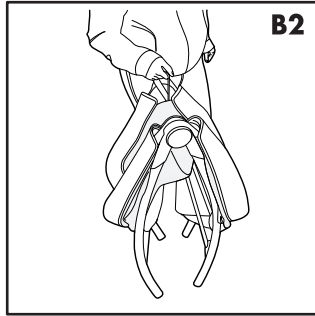
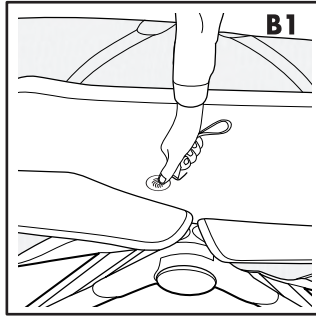

## CLEANING BASSINET

### Mattress Sheet and Travel Bag

Remove the mattress from the bassinet.  
Unzip the sheet cover and remove it from the mattress.  
Machine wash cold, gentle cycle and line dry.

### Mattress

Remove mattress sheet. Surface wash only with a clean damp cloth.

### Frame, Legs, and Bassinet Cover

Surface wash only with a clean damp cloth.

embrace every **first**<sup>™</sup>

help@thefirstyears.com / 1-800-704-8697 / www.thefirstyears.com

THE FIRST YEARS name and logo are the trademarks of TOMY,  
registered in the U.S. and other countries.

© 2021 TOMY, TOMY INTERNATIONAL, 2015 SPRING RD., OAK BROOK, IL 60523 USA.

ALL RIGHTS RESERVED. STYLES AND COLORS MAY VARY. MADE IN CHINA.

Y7866 022421

**TOMY**<sup>®</sup>

the **first** years<sup>®</sup>

## First Dreams<sup>™</sup> Portable Bassinet

Y7866

0m+

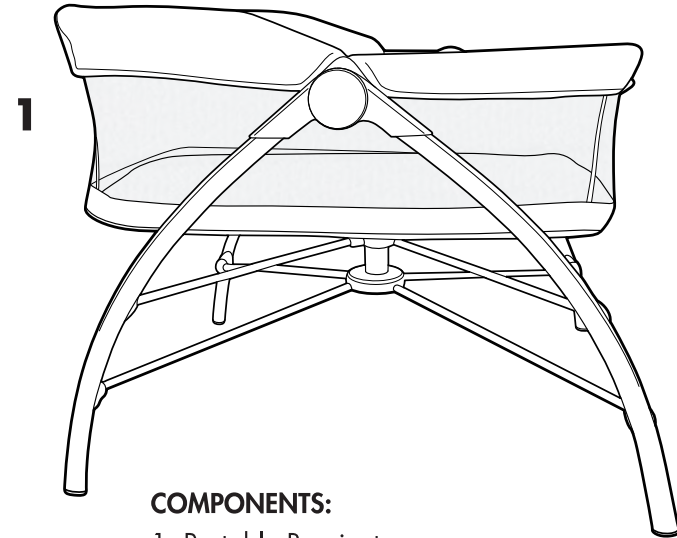

### COMPONENTS:

1. Portable Bassinet
2. Mattress and Mattress Sheet Cover
3. Travel Bag

2

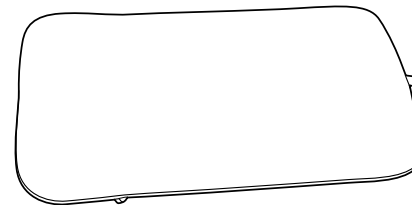

Mattress size: 17.7 in (w) x 31 in (l)

3

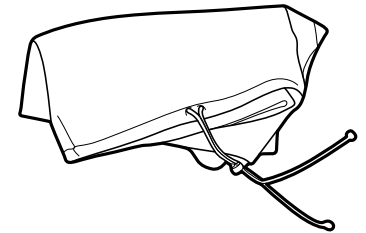

**READ ALL INSTRUCTIONS BEFORE USING.**

**KEEP THESE INSTRUCTIONS FOR  
FUTURE REFERENCE.**

**FOR HOUSEHOLD USE ONLY.**

## ⚠ WARNING

Failure to follow these warnings and instructions could result in serious injury or death.

- Read and follow instructions before assembly and use. If you do not have instructions, DO NOT use this product. Call 1-800-704-8697 or visit [www.thefirstyears.com](http://www.thefirstyears.com).
  - Before each usage and assembly, inspect bassinet for damaged hardware, loose joints, missing parts or sharp edges.
  - DO NOT use bassinet if any parts are missing or broken. Contact or write to The First Years for replacement parts and instructional literature if needed. DO NOT substitute parts.
  - NEVER leave child unattended in an adult bed.
- FALL HAZARD** - To help prevent falls, do not use this product when the infant begins to push up on hands and knees or has reached 20 lbs. (9kg), whichever comes first.
- Do not place any cord, strap or similar item in or near this bassinet that could become wrapped around a child's neck.
  - Do not place this bassinet near a window or patio door where a child could reach the cord of a blind or curtain and be strangled.

# SUFFOCATION HAZARD

Infants have suffocated:

- In gaps between extra padding and side of the bassinet/criadle, and
- On soft bedding

Use only the pad provided by The First Years. NEVER add a pillow, comforter, or another mattress for padding. If a sheet is used with the pad, use only the one provided by The First Years. To reduce the risk of SIDS, pediatricians recommend healthy infants be placed on their backs to sleep, unless otherwise advised by your physician.

**SAVE THESE INSTRUCTIONS**

- ALWAYS ensure mattress is positioned correctly. Do Not create any pockets between the mattress and mesh sides.
- ALWAYS place child to sleep on their back in this product.

## Strangulation Hazard

- Strings can cause strangulation! **DO NOT** place items with a string around a child's neck such as hood strings or pacifier cords. **DO NOT** suspend strings over sleeper or attach strings to toys.
- **DO NOT** place sleeper near a window where cords from blinds or drapes can strangle a child.

### SETTING UP BASSINET

1. Hold both sides of bassinet and lift up. (Fig. A1)
2. Push down on center hub until it clicks. (Fig. A2)

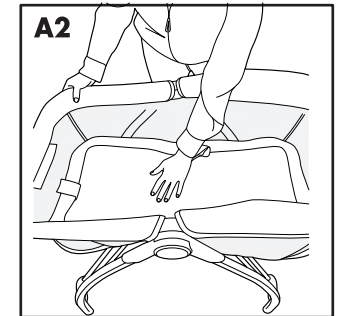
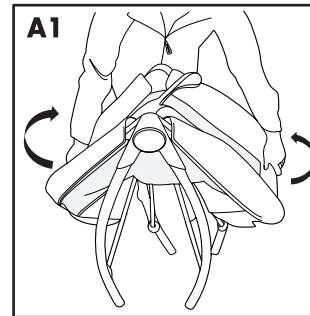

3. Place the mattress into the bassinet with the cushioned side facing up. Check that all sides are locked in place before using. (Fig. A3)
4. Ensure mattress is securely in place. (Fig. A4)

